

Original papers

Soft simulator for redesigning of a chickpea harvester header

Hiwa Golpira^{a,*}, Hêmin Golpîra^b^a Department of Biosystems Engineering, University of Kurdistan, Sanandaj, Iran^b Department of Electrical and Computer Engineering, University of Kurdistan, Sanandaj, Iran

ARTICLE INFO

Article history:

Received 26 March 2015

Received in revised form 10 February 2017

Accepted 17 February 2017

Available online 24 February 2017

Keywords:

Chickpea

Design

Fuzzy modeling

Genetic algorithm

Harvesting losses

Model-based engineering

Structural optimization

ABSTRACT

This paper proposes a new framework to tackle computer-aided modeling and evolutionary algorithms into conventional design phase of a machine, which, in turn, significantly reduces time and cost of structural optimization. The model-based engineering approach overcomes the crudity of hard modeling, field experiments and statistical analysis for finding the optimum structure of a design. Genetic algorithm incorporated with fuzzy modeling established a hybrid computational algorithm which predicts optimal sizing of a platform, developed for a chickpea harvester header. The harvesting losses of the platform's configurations in field trials were fed to the metaheuristic approach to develop a soft simulator for redesigning of the machine. Acceptable harvesting performance of the optimized harvester in field trials confirmed the robustness feature of the experiments based simulator. Further the results validated the virtual model and verified the reliability of the automatically generated harvester. The methodology can be employed for structural optimization of mechanical systems.

© 2017 Elsevier B.V. All rights reserved.

1. Introduction

Time-consuming and costly development of the conventional design methodology are difficulties for prototyping a concept and reaching optimal solution. During last decades, conceptually designed headers and harvesters were tried for chickpea (*Cicer arietinum* L.) harvesting (Bansal and Sakr, 1992; Behroozi-Lar and Huang, 2002; Konak et al., 2002; Siemens, 2006), but acceptable performance has not been achieved yet. The problem becomes more acute when mechanical harvesters applied for harvesting rainfed chickpeas cultivated in fallow fields.

In 2006, available information on the physical, mechanical, and aerodynamic properties of chickpea seeds was reviewed for designing of a chickpea harvester. Terminal velocity, Reynolds number, sphericity, dimensions, densities, mass, volume hardness, impact velocity, coefficient of friction and drag force were surveyed for designing of a concept. For instance, length, width, thickness and geometric mean diameter of chickpeas seed were determined 9.34, 7.72, 7.75 and 8.5 mm, respectively. Later, the gathered information was published by (Golpira, 2015). In 2009, a tractor-pulled harvester with modified stripper header was

conceptually designed and fabricated for chickpea harvesting. A platform, with 1 m working width, was accompanied by a batted reel to develop a modified stripper harvester header. The platform with forward-opening fingers produced a harvester header, in which the plants move through the V-shaped slots and are stripped. The platform supports the passive fingers and delivers the harvested material. Reel with three bats sweeps the pods across the platform and pushes the top of the chickpeas over the header. A conveyor with an endless chain sweeps the harvested material which falls onto the header (Golpira et al., 2013). In 2011, the tractor-pulled harvester was redesigned to a tractor-mounted harvester which benefits from advantages of pneumatic conveyors (Golpira, 2013). In addition to adaptability of the floating header with ground unevenness, field environmental impacts have moderated by two tire wheels located on both sides of the header. This causes the performance of the harvester is kept acceptable in different fields. Field experiments results confirmed that the structural optimization of the platform can reduce losses. However, hard modeling, field experiments, and statistical analysis are time and cost-consuming tools for decision-making in conventional design of a concept.

Nature of computer-based design models and evolutionary algorithms provides some opportunities that cannot be obtained through conventional approaches. Fuzzy Modeling (FM), Genetic Algorithm (GA), differential evolution, harmony search, particle swarm and ant colony optimizations, bee, bat and firefly algo-

Abbreviations: FM, fuzzy model; GA, genetic algorithm; MF, membership function.

* Corresponding author.

E-mail address: h.golpira@uok.ac.ir (H. Golpira).

Nomenclature

W	slot width	l	total losses, %
L	finger length	L_p	weight of remained pods on the plant, kg
D	keyhole diameter	L_s	weight of shattered pods on the ground, kg
E	entrance width		
H_p	weight of harvested pods on the header, kg		

rithms, cuckoo search, charged system search and krill herd are utilized for modeling and optimization (Babuska, 2001; Gandomi et al., 2011, 2013; Saridakis and Dentsoras, 2008). While modeling approaches are employed to visualize performance of a system, bio-inspired algorithm attains the required knowledge to converge at optimum solution from the fitness function in the evolutionary process. Two types of rule-based fuzzy models are Mamdani and Takagi–Sugeno. While the early one is determined by linguistic description of both antecedent and consequent, the later, known as Takagi–Sugeno (Takagi and Sugeno, 1985), is described by linguistic antecedent and crisp consequent. The linguistic fuzzy model, introduced by (Mamdani, 1977; Zadeh, 1973), is appropriate for structural optimization problems (Kicinger et al., 2005). GA is a powerful optimization technique, capable of being applied to a wide range of optimization problems that enables to perform randomized global search in a solution space. GA produces an exhaustive set of variables that covers all the search space of possible solutions in an optimal way. Combination of two or more above mentioned metaheuristic approaches produces hybrid algorithms for model-based engineering solutions. It should be noted that while evolutionary algorithms and hybrid models are common tools to deal with control systems (Jamshidi, 1996), their ability in designing a concept is neglected in literature.

In this research, a soft simulator was developed to optimize performance of a platform, designed for chickpea harvesting. FM incorporated with GA provides an experiment-based hybrid model for structural optimization of the machine. The virtual harvester reduces design cost and time through mimics the behavior of the machine to predict harvesting losses.

The rest of this paper is organized as follows. Section 2 presents the harvesters, models and design variables. Section 3 describes real and virtual field evaluations. Section 4 develops the soft simulator. Section 5 validates the hybrid model, and finally Sec-

tion 6 compromises a framework for structural optimization of concepts.

2. Machine design

2.1. Platform configurations

Platform variables of slot width, finger length, keyhole diameter and entrance width would be modified in order to minimize the harvesting losses (Fig. 1). The sizing optimization problem is formulated as:

$$\text{Minimize Losses} = F(W, L, D, E) \tag{1}$$

where $W, L, D,$ and E are slot width, finger length, keyhole diameter, and entrance width, respectively.

Eighteen steel platforms were built and evaluated in field trials. The design variables of the fabricated platforms are illustrated in Table 1. Platform with slot widths of 40- and 70-mm and finger lengths of 150- and 200-mm were the preliminary models (Nos. 1, 2 and 3). The width of these platforms was 100 cm. These models were tried during year 2009 on the tractor-pulled harvester (Fig. 2). The optimal design included a slot width of 40 mm and finger lengths of 200 mm. As the long fingers produce high losses, the finger lengths were reduced to 95-mm. Further, Keyhole, a hole at the base of the fingers, was added to the platform structure. Platform with the slot width of 72-mm, finger length of 95-mm, keyhole diameter of 16-mm and entrance width of 10-mm (No. 4) was the baseline for the redesigned harvester (Fig. 3). The width of this platform was 140 cm.

To reduce cost and time, a simple harvester was fabricated for testing the platform configurations (Fig. 4). An adjustable screw adjusts height of platforms above the ground. This human-handled harvester is utilized to test ten fabricated platforms, i.e. configuration Nos. 5–14 in Table 1. The width of these platforms

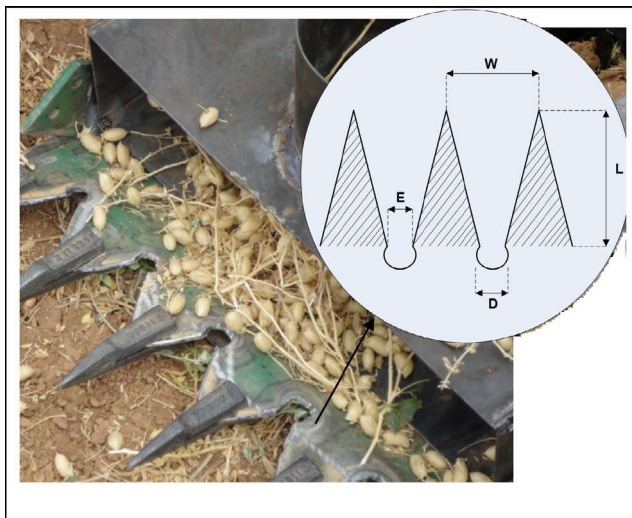

Fig. 1. Platform with design variables of D: Keyhole diameter; E: Entrance width; L: Finger length; W: Slot width.

Table 1
Platform configurations fabricated for chickpea harvesting.

Platforms	Design variables (mm)			
	Slot width	Finger length	Entrance width	Keyhole diameter
1	70	150	–	–
2	40	200	–	–
3	40	150	–	–
4	72	95	10	16
5	72	95	13	16
6	40	40	6	6
7	58	95	12	13
8	58	95	10	17
9	58	40	12	13
10	58	40	10	17
11	40	40	7	10
12	40	40	14	15
13	40	40	8	11
14	72	95	6	12
15	–	–	13.5	15.5
16	–	–	6.5	9
17	–	–	5.5	13.5
18	–	–	12.5	16



Fig. 2. Tractor-pulled harvester with modified stripper header fabricated for chickpea harvesting.

was 35 cm. Further, four models were developed and tried out-of-field in laboratory for size optimization of the keyhole and entrance width (Nos. 15–18). Keyhole diameters and entrance widths ranged respectively, from 6- to 17-mm and 6- to 14-mm.

Each platform was a redesigned version of the previous one with modified functional operators of keyhole diameter, finger length, slot width and entrance width. Some platforms were combined with each others to form a new configuration with lower losses in comparison with the constituent platforms. It could be seen, as will be discussed in next section, that the rationale behind the conventional design is the same with the soft computing methodology. In this way, designing of a new model based on functional operators modifications and combination of platforms could be considered as mutation and crossover, respectively. Crossover combines the pairs of chromosomes promoted by selection operator to generate the new candidates (Golpira et al., 2011; Loia et al., 2000). Mutation changes a single bit value in chromosomes randomly to explore the global design space.

2.2. Genetic algorithm

The algorithm begins with a set of initial random population represented in chromosomes, that is, a string of genes representing an encoding of a candidate solution (Coley, 1999; Hajela and Lin, 1992; Huang et al., 2010). GA, which is utilized to minimize the

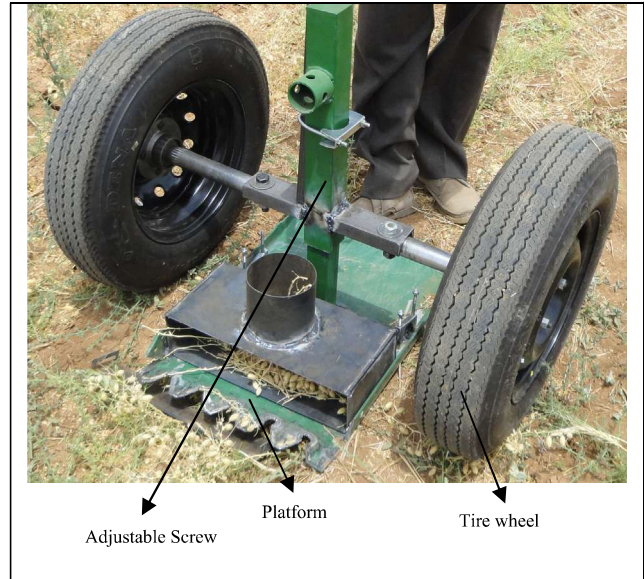

Fig. 4. Human-operated harvester fabricated for testing of the platform configurations.

harvester losses, is characterized by initial population of 400 chromosomes; 40 binary genes, representing *W, L, E, D*, for a chromosome and 10 gens for each input variable. Genetic operators, known as selection, crossover and mutation, acts on the initial population to reproduce new generation. Selection is a procedure that individual chromosomes are selected from population for the later mate. These chromosomes are applied to the developed fuzzy-based model (will be discussed in next section) to estimate the harvester losses. The chromosomes then are sorted based on the harvester losses to specify the more fit individuals. The algorithm gradually modifies the more fit individuals to form next generation. Fitness proportionate selection method, known as roulette-wheel selection method, is used to select the elite strings for recombination. This would be visualized through dividing of each individual fitness to the summation of fitness for all the individuals in the generation. Chromosomes with higher fitness values have higher chance to be selected for breeding.

The selected individuals, through roulette-wheel selection method, incorporated with crossover and mutation to evolve toward optimal solution. Generally two crossover operators, namely, normal and mathematical, are applied in the optimiza-

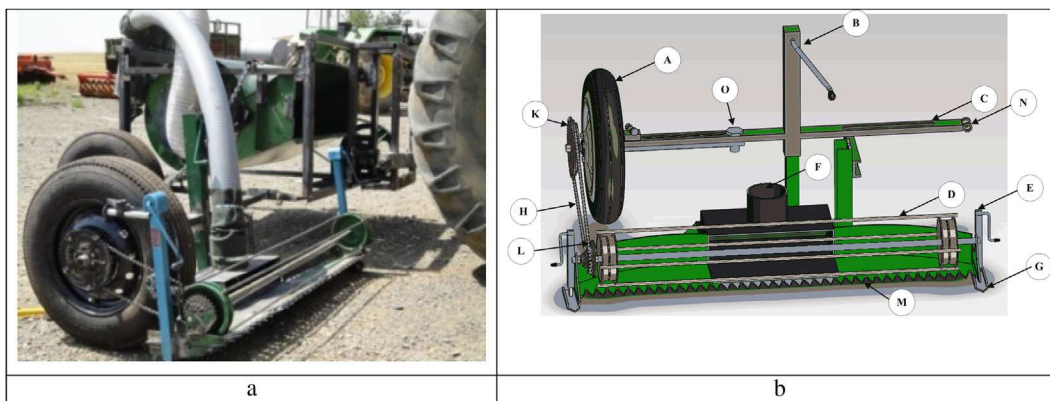

Fig. 3. (a) Tractor-mounted harvester with redesigned stripper header (b). Redesigned stripper header. A: Ground wheel; B: Adjustable screw; C: Frame; D: Reel; E: Adjustable screw; F: Conveyor input; G: Shoe; H: Chain; K: Ground wheel sprocket; L: Reel sprocket; M: Platform; N: Hitch point.

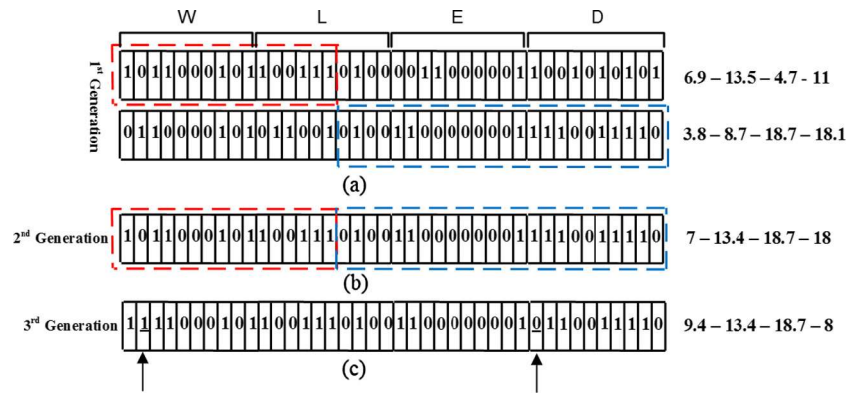

Fig. 5. Formation of new virtual platforms by GA. (a) Two typical chromosomes in first generation, (b) generated platforms by means of crossover, (c) generated platform by means of mutation.

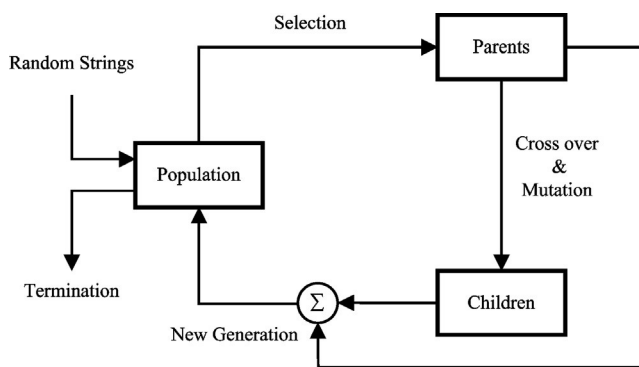

Fig. 6. A general scheme for Genetic Algorithm (Golpîra et al., 2011).

tion problems. Normal, the most suitable, substitution elimination and dual displacement are mutation operators which used to improve the optimization procedure (Seifi and Sepasian, 2011). The normal crossover and mutation are employed with probabilities of 0.8 and 0.05, respectively. However, it was shown by (Boyabatli and Sabuncuoglu, 2004) that effects of mutation and crossover probabilities as well types of them on the best fitness value are negligible. The resulting chromosomes from crossover and mutation define a set of chromosomes, known as children. The new generation consists of the fitter chromosomes of the old population (parents) and the children. Fig. 5 explains formation of new virtual platforms by means of GA. The chromosomes represented in Fig. 5(a) are two typical chromosomes which are promoted by selection procedure for breeding. Fig. 5(b) demonstrates formation of a typical new platform, i.e. children, from two exist platforms, i.e. parents, in the second generation. In this way, crossover visualizes through combination of genes surrounded in the dash and dot rectangles. Fig. 5(c) reveals formation of a new platform in the third generation by means of mutation. This chromosome is assumed to be generated from Fig. 5(b) after action of mutation operator. The mutated genes in Fig. 5(c) are shown by arrows. These steps continue until the termination condition, a situation where the highest ranking solution's fitness, is satisfied (Fig. 6). The algorithm stops when the change in the fitness function values over successive generations is less than function tolerance, i.e. 0.001. Moreover, in order to guarantee the optimal solution, GA runs several times in such a way that in each run the initial population set to the final population from the previous run. Over successive generations, the population evolves toward an optimal solution.

3. Field evaluation

3.1. Harvesting losses

Field evaluations were conducted to determine machine performance based on shattering losses and pods remaining on anchored plants. The experiments were performed on the Dooshan farm of University of Kurdistan, Gerize farm of Sanandaj Agricultural Research Center and Saral farm of Kurdistan Agriculture Research Center during the summers of 2007–2012 using a very common chickpea variety, Kabuli, on the typical fallow fields. The harvesters were operated along the rows and losses, excluding pre-harvest losses, were measured after harvesting. Details regarding the harvesters, evaluation methodology, statistical analysis, design of experiments and selection of discrete values were precisely elaborated in (Golpîra, 2013; Golpîra et al., 2013). Losses comprise the weight of pods that has been shattered by the header (L_s) and those remained on the plant (L_p) which was measured by collecting them in field and calculated by the following equation:

$$L = \frac{L_p + L_s}{L_p + L_s + H_p} \times 100 \quad (2)$$

where H_p , L_s and L_p are the weight (in kg) of harvested pods on the header, detached pods on the ground (shattering losses) and remained pods on the plant after harvesting, respectively.

3.2. Fuzzy modeling

Fuzzy Model (FM) aims to do the same work as field evaluation, where the harvester losses analyze. Fuzzy modeling characterizes with fuzzification, generating of Fuzzy Associate Memory (FAM), defuzzification and settles by validation in order to be appropriate for optimization purpose (Babuska, 2001; Jamshidi, 1996; Kumru and Kumru, 2013). Input variables of slot width (W), finger length (L), keyhole diameter (D), and entrance width (E) were specified to generate losses output (I). The fuzzified inputs and outputs, named antecedent and consequent in rule-based system, defined by Membership Functions (MFs), depicted in Fig. 7. Since fuzzy modeling partially depends on the designers' intention (Espinosa et al., 2005), fuzzification relies on the pre-specified losses levels, i.e. accepted, marginal and rejected. In this way, each input variable is varied in a defined range while the others are considered constant. Any significant change in losses in response to studied variable variation leads to definition of a MF. For example, for entrance width more than 12 mm, stems escape from keyholes before stripping. Large entrance widths do not grab anchored stems which in turn increases pod losses and reduces harvesting quality. Table 2

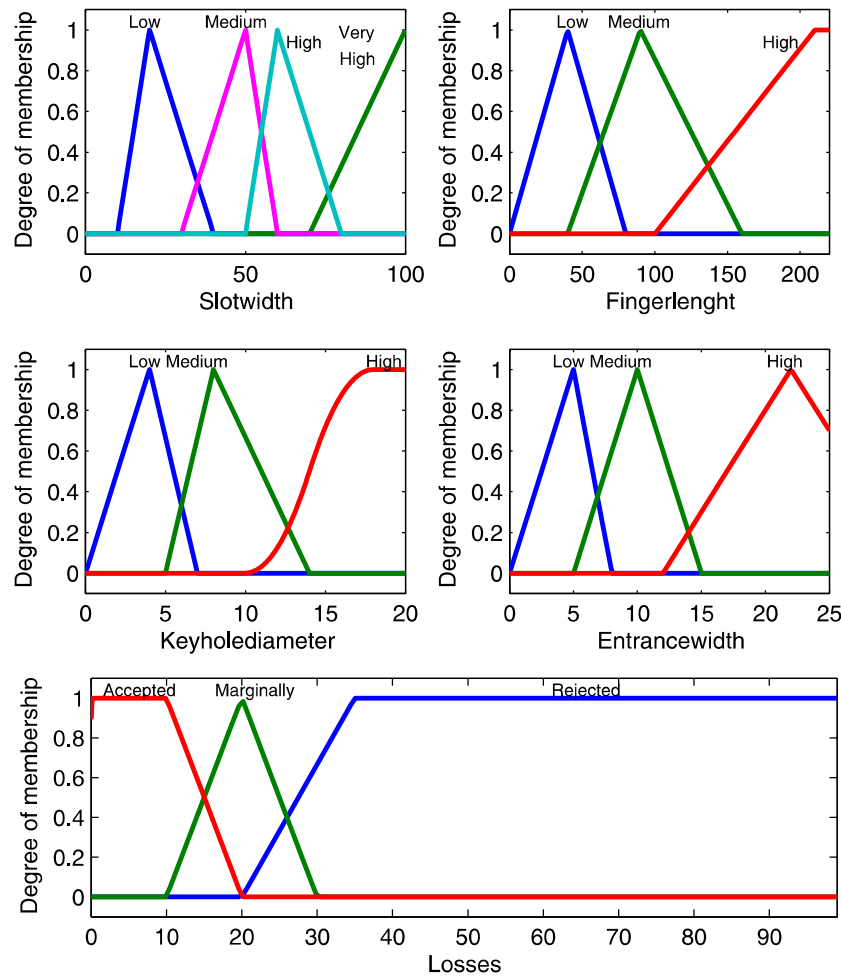

Fig. 7. Fuzzy membership functions for the inputs (finger length, slot width, keyhole diameter and entrance width)-output (harvesting losses) model.

summarizes the designer knowledge on which MFs in Fig. 7 are defined based on. Desired zones are those which their behavior is accepted in field experiments.

The gathering data, represented in Table 1, in corporation with the defined MFs are employed to generate a set of if-then rules, called FAM bank. FAM bank contains a set of linguistic relationship between design variables. The result was a fuzzy-based model which determines the mapping function of:

$$F : (W, L, E, D) \rightarrow I \quad (3)$$

While fuzzification converts crisp input data to fuzzy values, using membership functions, defuzzification regenerates crisp values as the output of the model. The Max-Min inference scheme (Mamdani, 1977) which uses center of gravity was employed to defuzzify output values. Mamdani inference method does not require any discretization and thus can work with analytically defined MFs (Babuska, 2001).

4. Soft simulator

An experiment-based hybrid model was developed to minimize harvesting losses of the chickpea harvester header. FM helps designer to quantify expert knowledge and facilitates optimized design through GA. A general description of the proposed hybrid algorithm can be explained by the following steps:

Step 1: Fabricating of a platform to harvest chickpea

Step 2: Evaluating of the fabricated platform to determine harvesting losses

Step 3: Feeding of the evaluation data, in the form of if-then rules, to fuzzy system for developing a fuzzy model

Step 4: Return to Step 1, repeat until the developed model results match the practical results

Step 5: Applying GA to the validated fuzzy model to calculate optimal W, L, E, D .

Step 6: Fabrication of the platform (concept) based on the optimal functional operators.

The above steps are summarized in the flowchart of Fig. 8. Model validation, robustness justification and an overview of the economic aspects of the hybrid simulator will be discussed in the following section.

5. Results and discussion

Visualization of virtual field and designer knowledge through GA and fuzzy model not only omits necessity for fabricating and evaluating of new models but also provides a simulator to predict losses and optimize the machine. Fig. 9 describes two portraits of relationship between losses and the input variables. The minimum losses were 10% for the optimal structure, where GA determines the slot width of 40-mm, finger length of 40-mm, keyhole diameter

Table 2
Membership functions definition procedure.

Keyhole diameter	Low	Not enough space for stems, they go out of keyhole
	Medium	Desired zone
	High	Pods are not detached from anchored plant
Finger length	Low	Desired zone
	Medium	Desired zone
	High	Plants broke before stripping
Entrance width	Low	Stems cannot enter to keyholes
	Medium	Desired zone
	High	Stems escape before harvesting
Slot width	Low	Plants break
	Medium	Desired zone
	High	Desired zone
	Very High	Plants break
Losses	Accepted	High performance
	Marginal	Tradeoff between economic and performance
	Rejected	Lack of economic and performance merits

of 10-mm and entrance width of 6-mm. The optimized platform with 140 cm width was assembled on the redesigned harvester and tried in field experiments. The powerfulness of the proposed modeling and hybrid approach was proved by comparing the output of the simulator with field experiments and observations.

Validation results for the developed model are shown in Fig. 10, where the predicted losses are plotted against the real losses. In other words, Fig. 10 is aimed to assure that the model represents the real-world header to a sufficient level of accuracy. This, as the process of model validation, is done through comparing of the actual harvesting losses, associated with those configurations reported in Table 1, and the predicted ones by the proposed soft simulator. If a model gives rise to $R > 0.8$, and error values, e.g., RMSE and MAE, are at minimum, there is a strong correlation between the predicted and measured values. R , RMSE and MAE are, respectively, correlation coefficient, root mean squared error and mean absolute error, formulated by (Gandomi et al., 2011). It can be observed from Fig. 9 that the proposed model is able to predict the losses values to a satisfactory degree of accuracy.

Field experiments and observations, obtained from testing of the platform in five fields, validated the robustness feature of the simulator/platform and suitability of the framework for most of application environments. The proposed simulator and sequentially the designed platform are robust enough to be employed in any field without any concerns. The model can therefore be judged as efficient/good and can be employed with high reliability in the harvester analysis behavior.

The proposed hybrid algorithm is general enough to be applied to any mechanical system without any concerns. Justification of such claim is done through sensitivity analysis which in turn demonstrates independency of the proposed soft simulator from the FM and GA parameters. While it was shown previously that fuzzification procedure and GA operators have no effects on the model functionality, sensitivity analysis revealed that the number of chromosomes has no significant impact on the best fitness value. For this purpose, the best fitness values are calculated for the various population sizes in the range of [50–600]. Simulation results showed that the impact of population size on the best fitness value is less than 1%. On the other hand, number of genes has no significant effects on mechanical system design. For instance, considering 10 bits for keyhole diameter with maximum value of 20 mm leads to 0.02 mm, i.e. $20/(2^{10} = 1024)$, precision and 0.6 mm, i.e. $20/(2^5 = 32)$ for 5 bits. For the present platform design, mechanical constraints do not allow to fabricate variable with precision less

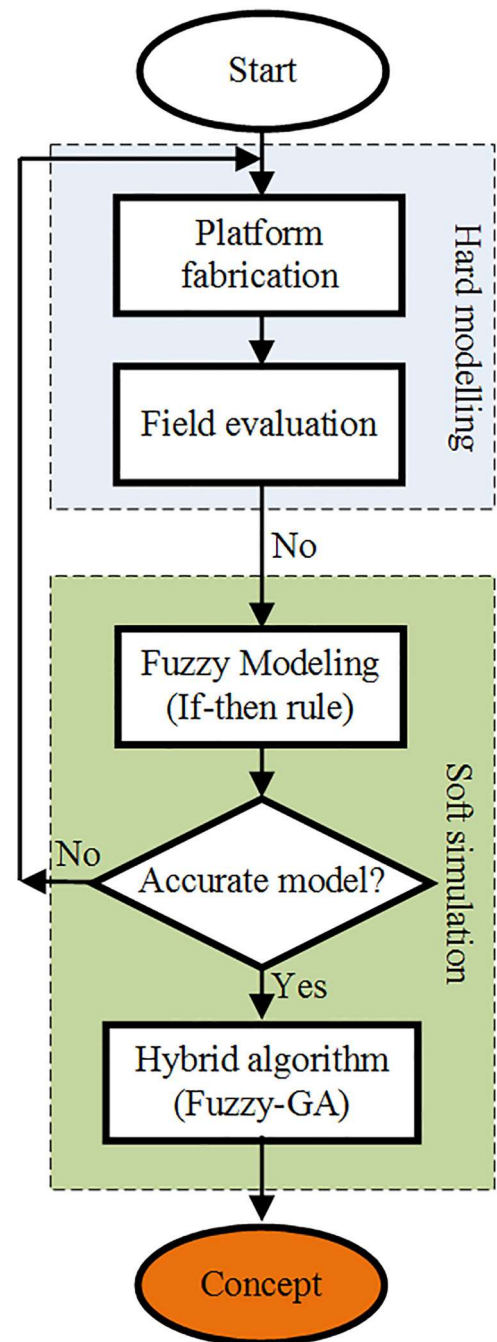

Fig. 8. Flow chart representation of the optimization process of the platform concept.

than 1 mm. As the machine is in concept phase, any number of genes more than 4 bits is acceptable. However, in manufacturing phase larger number of genes, which specifies greater precision, leads to exact optimized structure.

The simulator tests approximately 4000 (10 iterations \times 400 chromosomes) platform configurations in less than one minute with no cost. In contrast, in conventional design methodology eighteen platforms (24 trials) were fabricated during five years with cost of 1200\$ per trial. It could be clearly seen that while the both methods, i.e. conventional design and hybrid method, do the same work, virtual model significantly reduces cost and time to reach the optimal design.

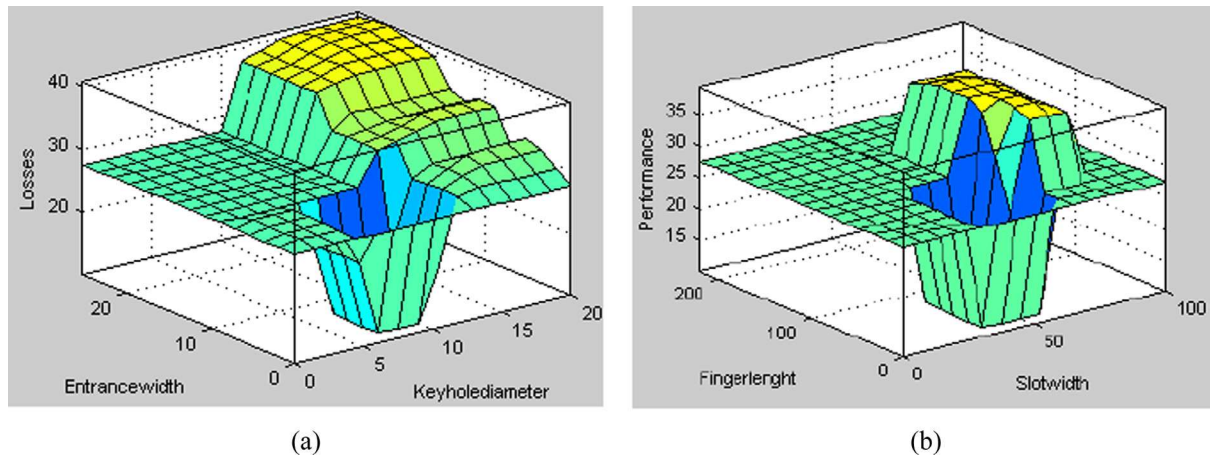

Fig. 9. Response of the fuzzy model to predict harvesting losses. Portraits of model response which consists of two input variables of (a) keyhole diameter and entrance width (b) finger length and slot width.

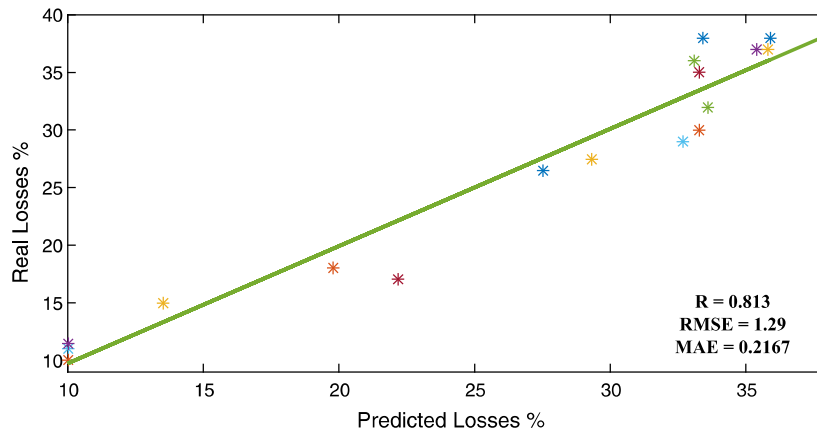

Fig. 10. Comparison of the platform losses versus the predicted losses on a validation set.

6. Conclusion

This paper proposed a model-based engineering method for structural optimization of a machine, and a framework for simulation of mechanical systems. Fusion of GA, FM and experimental data produced a soft simulator which was developed for structural optimization of a harvesting platform. The effectiveness of the algorithm would be accepted since the field evaluation results of the harvester validated the robustness of the model and confirmed the performance of the concept for chickpea harvesting. The soft harvester not only provided reliable framework for out-of-season evaluation but also significantly reduced design cost and time. The virtual model make a tradeoff, in respect to economic and performance features, between hard modeling and soft computing. Prototyping of the simulator is considered for the next stage of the improvement.

Acknowledgments

The authors gratefully acknowledge the INSF (Iran National Science Foundation) for the financial support through project 'Design, modeling and development of a chickpea harvester' with project number 89003079.

References

Babuska, R., 2001. Fuzzy Systems, Modeling and Identification. Delft University of Technology, Department of Electrical Engineering Control Laboratory, Mekelweg 4.

- Bansal, R., Sakr, B., 1992. Development of a vertical conveyor reaper for harvesting chickpeas and lentils in Morocco. *Appl. Eng. Agric.*
- Behroozi-Lar, M., Huang, B., 2002. Design and development of chickpea combine. *Agric. Mech. Asia Africa and Latin America* 33, 35–38.
- Boyabatli, O., Sabuncuoglu, I., 2004. Parameter selection in genetic algorithms. *J. Syst. Cybern. Inform.* 4, 78.
- Coley, D.A., 1999. An Introduction to Genetic Algorithms for Scientists and Engineers. World Scientific Singapore.
- Espinosa, J., Vandewalle, J., Wertz, V., 2005. Constructing Fuzzy Models from Input-Output Data. *Fuzzy Logic, Identification and Predictive Control*, pp. 21–58.
- Gandomi, A.H., Alavi, A.H., Mousavi, M., Tabatabaei, S.M., 2011. A hybrid computational approach to derive new ground-motion prediction equations. *Eng. Appl. Artif. Intell.* 24, 717–732.
- Gandomi, A.H., Yang, X.-S., Talatahari, S., Alavi, A.H., 2013. Metaheuristic Applications in Structures and Infrastructures. Newnes.
- Golpira, H., 2013. Conceptual design of a chickpea harvesting header. *Spanish J. Agric. Res.* 11, 635–641.
- Golpira, H., 2015. Redesign and evaluation of a chickpea harvester. *J. Biosyst. Eng.* 40, 102–109.
- Golpira, H., Bevrani, H., Golpira, H., 2011. Application of GA optimization for automatic generation control design in an interconnected power system. *Energy Convers. Manage.* 52, 2247–2255.
- Golpira, H., Tavakoli, T., Baerdemaeker, J., 2013. Design and development of a chickpea stripper harvester. *Spanish J. Agric. Res.* 11, 929–934.
- Hajela, P., Lin, C.-Y., 1992. Genetic search strategies in multicriterion optimal design. *Struct. Optim.* 4, 99–107.
- Huang, Y., Lan, Y., Thomson, S.J., Fang, A., Hoffmann, W.C., Lacey, R.E., 2010. Development of soft computing and applications in agricultural and biological engineering. *Comput. Electron. Agric.* 71, 107–127.
- Jamshidi, M., 1996. Large-scale systems: modeling, control, and fuzzy logic.
- Kicinger, R., Arciszewski, T., Jong, K.D., 2005. Evolutionary computation and structural design: a survey of the state-of-the-art. *Comput. Struct.* 83, 1943–1978.
- Konak, M., Carman, K., Aydin, C., 2002. PH—Postharvest Technology: physical properties of chick pea seeds. *Biosyst. Eng.* 82, 73–78.
- Kumru, M., Kumru, P.Y., 2013. Fuzzy FMEA application to improve purchasing process in a public hospital. *Appl. Soft Comput.* 13, 721–733.

- Loia, V., Sessa, S., Staiano, A., Tagliaferri, R., 2000. Merging fuzzy logic, neural networks, and genetic computation in the design of a decision-support system. *Int. J. Intell. Syst.* 15, 575–594.
- Mamdani, E.H., 1977. Application of fuzzy logic to approximate reasoning using linguistic synthesis. *Comput. IEEE Trans.* 100, 1182–1191.
- Saridakis, K.M., Dentsoras, A.J., 2008. Soft computing in engineering design – a review. *Adv. Eng. Inform.* 22, 202–221.
- Seifi, H., Sepasian, M.S., 2011. *Electric Power System Planning*. Springer.
- Siemens, M., 2006. Effect of guard spacing, guard attachments and reel type on chickpea harvesting losses. *Appl. Eng. Agric.* 22, 651.
- Takagi, T., Sugeno, M., 1985. Fuzzy identification of systems and its applications to modeling and control. *Syst. Man Cybern. IEEE Trans.*, 116–132.
- Zadeh, L.A., 1973. Outline of a new approach to the analysis of complex systems and decision processes. *Syst. Man Cybern. IEEE Trans.*, 28–44.